

# PRODUCT DATASHEET

## SF CIRC 350 SEN V 18W 3CCT IP44

SURFACE CIRCULAR 350 3CCT SENSOR | Wall and ceiling luminaire with IP44, high frequency sensor and selectable CCT



### Areas of application

- Corridors
- Stairways
- Bathrooms
- Foyers

### Product benefits

- Easy adjustment of sensor range, daylight detection and hold time
- Indoor luminaire with high luminous efficacy
- Highly versatile due to selectable CCT in 3000K, 4000K and 5000K
- Reduced overall height of only 75mm compared to standard version
- Energy savings of up to 55 % compared to luminaires that use CFL
- Easy and quick installation
- Very homogenous light
- 5 years guarantee

### Product features

- High frequency sensor for daylight and motion detection
- Type of protection: IP44 (ceiling mounting), IP20 (wall mounting)
- Impact resistance: IK03
- Metal housing, PMMA cover



- Ambient temperature in operation: -20...+40 °C
- Indoor use only, not suitable for outdoor use

## TECHNICAL DATA

### Electrical data

Nominal wattage	18.00 W
Nominal voltage	220...240 V
Mains frequency	50...60 Hz
Nominal current	85.000 mA
Inrush current	7.2 A
Inrush current time $T_{h50}$	5.6 $\mu$ s
Max. number of luminaires per miniature circuit breaker B16	104
Max. number of luminaires per miniature circuit breaker C10	83
Max. number of luminaires per miniature circuit breaker C16	133
Power factor $\lambda$	> 0.70
Total harmonic distortion	< 60 %
Protection class	I
Operating mode	Integrated LED driver

### Photometrical data

Luminous flux	1440 lm
Luminous efficacy	80 lm/W
Color temperature	3000 K / 4000 K / 5000 K
Reference control setting of contained light source (Kelvin)	4000 K
Light color (designation)	Warm White / Cool White / Daylight
Color rendering index Ra	> 80
Standard deviation of color matching	< 6 sdc <sub>m</sub>
Low flicker	Yes
Flickering metric (Pst LM)	< 1
Stroboscope effect metric (SVM)	< 0.4
Photobiological safety group acc. to EN62778	RG0
Beam angle	120 °

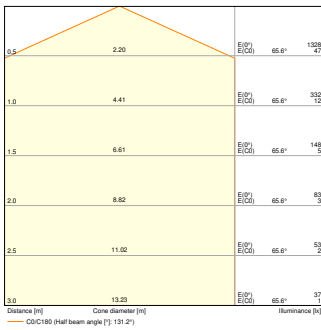

SF CIRC 350 SEN V 18W 3CCT 3000K IP44

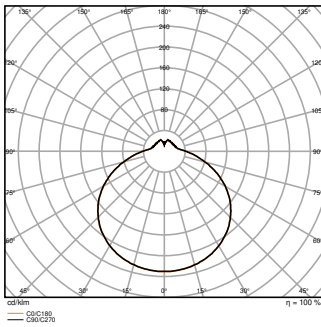

SF CIRC 350 SEN V 18W 3CCT 3000K IP44

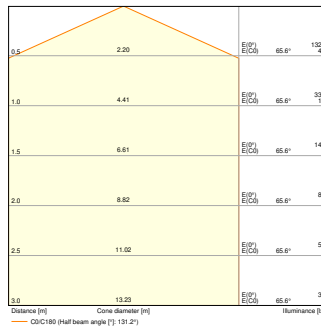

SF CIRC 350 SEN V 18W 3CCT 4000K IP44

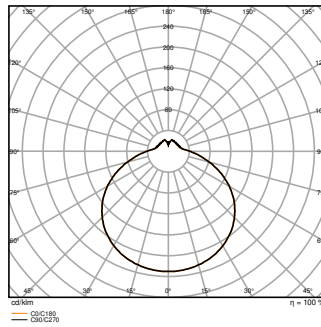

SF CIRC 350 SEN V 18W 3CCT 4000K IP44

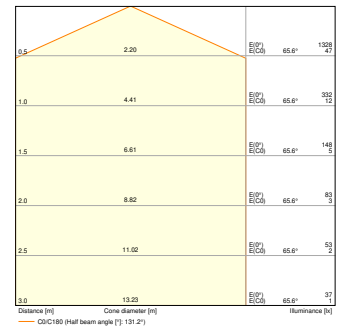

SF CIRC 350 SEN V 18W 3CCT 5000K IP44

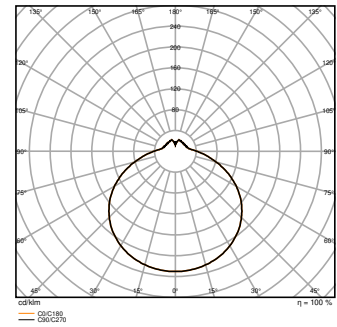

SF CIRC 350 SEN V 18W 3CCT 5000K IP44

Dimensions & Weight

Diameter	350 mm
Height	75.00 mm
Product weight	595.00 g

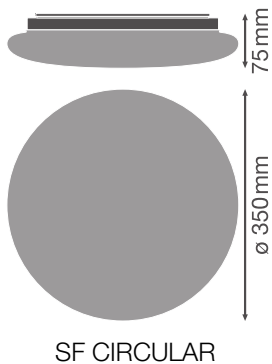

Materials & Colors

Product color	White
Housing color	White
Body material	Steel
Cover material	Polymethylmethacrylate (PMMA)
Light emitting surface material	PMMA
Glow Wire Test according to IEC 60695-2-12	650 °C
Mercury content	0.0 mg

### Application & Mounting

Ambient temperature range	-20...+40 °C
Temperature range at storage	-20...+80 °C
Type of connection	Terminal, 3-pin
Type of protection	IP44
Protection class IK (shock resistance)	IK03
Dimmable	No
Mounting type	Surface
Mounting location	Ceiling / Wall
Application environment	Indoor
LED module replaceable	Not replaceable
With light source	Yes

### Lifespan

Lifespan L70/B50 at 25 °C	50000 h <sup>1)</sup>
Lifespan L80/B10 at 25 °C	33000 h <sup>1)</sup>
Lifespan L90/B10 at 25 °C	15000 h
Number of switching cycles	100000

<sup>1)</sup> t[h]: L70 / B50 @ 25 °C (Ta), t[h]: L80 / B10 @ 25 °C (Ta), t[h]: L90 / B10 @ 25 °C (Ta)

### Control gear

Output current	220 mA
ECG - Output ripple current	< 5 %

### Sensor

Type of sensor	Motion / Light
Sensor technology	Microwave
Sensor detection angle	120 °

Sensor controlled switching time	5 s...30 min
Detection range of motion sensor	4...7 m
Detection threshold of daylight sensor	2...50 lx
Sensor IK rating	IK03

**Certificates & Standards**

Standards	CE / CB / TÜV / UKCA / EAC / EPD
Luminaire with limited surface temperature, "D sign"	No
Ball shot safe	No
EPD	LEDV-00010-V01.01-EN





**Additional product data**



Added function	MULTI SELECT
----------------	--------------



















**EQUIPMENT / ACCESSORIES**

– Replacement cover optionally available

**DOWNLOAD DATA**

Documents and certificates		Document name
	User Instruction	UI SF CIRC 350 V and SF CIRC 350 SEN V
	Addon Technical Information	LSI SF CIRCULAR 350
	Legal information	Legal Insert SF CIRC SEN V IP44
	Declarations of conformity	SF SQUARE and SF CIRC
	Declarations Of Conformity UKCA	SF SQUARE and SF CIRC

Photometric and lighting design files		Document name
	IES file (IES)	SF CIRC 350 SEN V 18W 3CCT 3000K IP44
	IES file (IES)	SF CIRC 350 SEN V 18W 3CCT 4000K IP44

Photometric and lighting design files		Document name
	IES file (IES)	SF CIRC 350 SEN V 18W 3CCT 5000K IP44
	LDT file (Eulumdat)	SF CIRC 350 SEN V 18W 3CCT 3000K IP44
	LDT file (Eulumdat)	SF CIRC 350 SEN V 18W 3CCT 4000K IP44
	LDT file (Eulumdat)	SF CIRC 350 SEN V 18W 3CCT 5000K IP44
	ULD file (DIALux)	SF CIRC 350 SEN 18W 3CCT IP44
	ROLF file (RELUX)	SF CIRC 350 3CCT SEN 18W 3CCT IP44
	UGR file (UGR table)	SF CIRC 350 SEN V 18W 3CCT 3000K IP44
	UGR file (UGR table)	SF CIRC 350 SEN V 18W 3CCT 4000K IP44
	UGR file (UGR table)	SF CIRC 350 SEN V 18W 3CCT 5000K IP44
	LDC typ cone	SF CIRC 350 SEN V 18W 3CCT 3000K IP44
	LDC typ cone	SF CIRC 350 SEN V 18W 3CCT 4000K IP44
	LDC typ cone	SF CIRC 350 SEN V 18W 3CCT 5000K IP44
	LDC typ polar	SF CIRC 350 SEN V 18W 3CCT 3000K IP44
	LDC typ polar	SF CIRC 350 SEN V 18W 3CCT 4000K IP44
	LDC typ polar	SF CIRC 350 SEN V 18W 3CCT 5000K IP44
CAD/BIM files		Document name
	BIM_Revit_3D	SURFACE CIRCULAR
	CAD_STEP_3D	SF CIRC 350
Tender texts		Document name
	Tender documents	SURFACE CIRCULAR 350 3CCT SENSOR 18W 3CCT IP44-EN

LOGISTICAL DATA

Product code	Packaging unit (Pieces/Unit)	Dimensions (length x width x height)	Gross weight	Volume
4099854042096	Folding box 1	87 mm x 382 mm x 384 mm	864.00 g	12.76 dm <sup>3</sup>
4099854042102	Shipping box 5	457 mm x 392 mm x 419 mm	5549.00 g	75.06 dm <sup>3</sup>

The mentioned product code describes the smallest quantity unit which can be ordered. One shipping unit can contain one or more single products. When placing an order, for the quantity please enter single or multiples of a shipping unit.

**ADDITIONAL CATALOG INFORMATION**

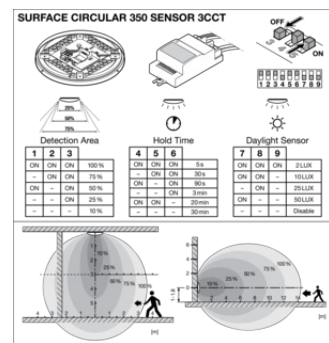
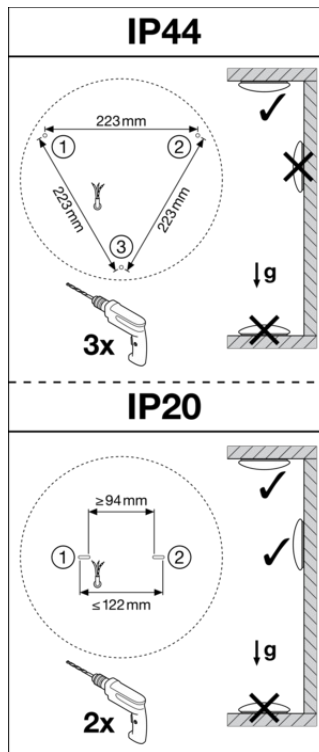
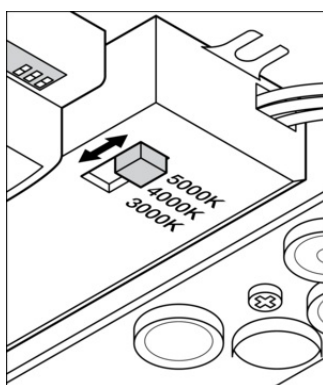
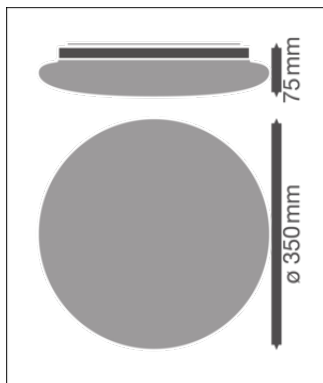

**References / Links**

- For Guarantee see [www.ledvance.com/guarantee](http://www.ledvance.com/guarantee)



---

## DISCLAIMER

Subject to change without notice. Errors and omission excepted. Always make sure to use the most recent release.