

# PRODUCT DATASHEET

## SF COMPACT IK10 300 24 W 4000 K IP65 WT

SURFACE COMPACT IK10 | Wall and ceiling luminaire with high impact resistance



### Areas of application

- Corridors
- Stairways
- Bathrooms
- Foyers
- Public areas

### Product benefits

- Slim profile
- Resistance against vandalism
- High luminous efficacy
- Very homogenous light
- LED protected for safe installation
- 5 years guarantee

### Product features

- Beam angle: 120°



- Type of protection: IP65
- Impact resistance: IK10
- Housing and cover made from polycarbonate
- Glow Wire Test according to IEC 60695-2-12: 850 °C
- Through-wiring possible

## TECHNICAL DATA

### Electrical data

Nominal wattage	24.00 W
Nominal voltage	220...240 V
Mains frequency	50...60 Hz
Nominal current	110 mA
Inrush current	15.6 A
Inrush current time $T_{h50}$	620 $\mu$ s
Max. number of luminaires per miniature circuit breaker B16	30
Max. number of luminaires per miniature circuit breaker C10	28
Max. number of luminaires per miniature circuit breaker C16	45
Power factor $\lambda$	$\geq 0.90$
Total harmonic distortion	< 20 %
Protection class	II
Operating mode	Integrated LED driver

### Photometrical data

Luminous flux	1920 lm
Luminous efficacy	80 lm/W
Color temperature	4000 K
Light color (designation)	Cool White
Color rendering index Ra	> 80
Standard deviation of color matching	$\leq 4$ sdc <sub>m</sub>
Luminous intensity	-
Low flicker	Yes
Flickering metric (Pst LM)	-
Stroboscope effect metric (SVM)	-
Photobiological safety group acc. to EN62778	RG0
Beam angle	120 °

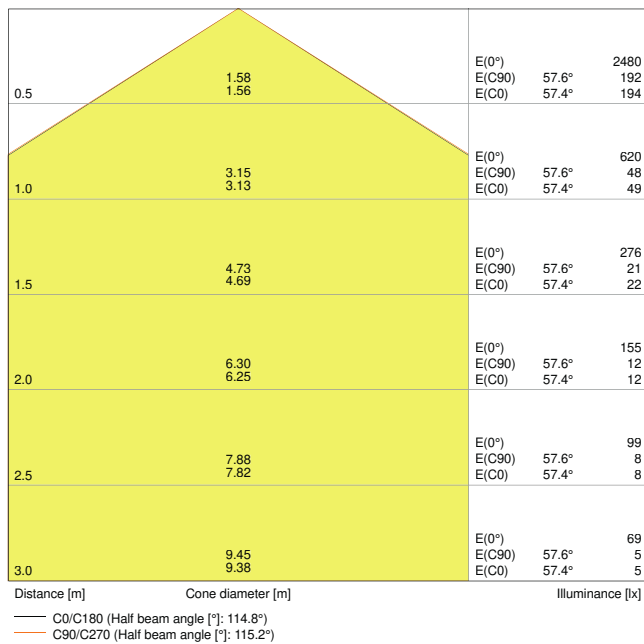

4058075062221 SF Compact RD300 24W 4000K IP65  
IK10 WT

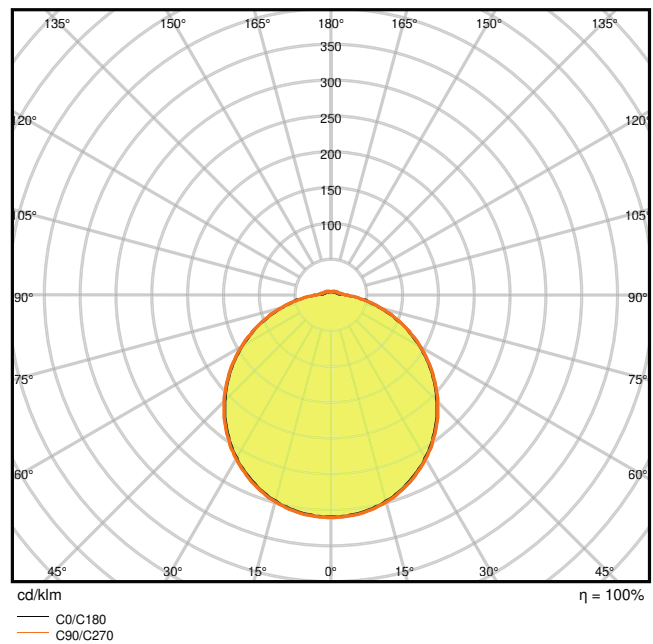

4058075062221 SF Compact RD300 24W 4000K IP65  
IK10 WT

Dimensions & Weight

Diameter	300.00 mm
Height	61.00 mm
Product weight	940.00 g

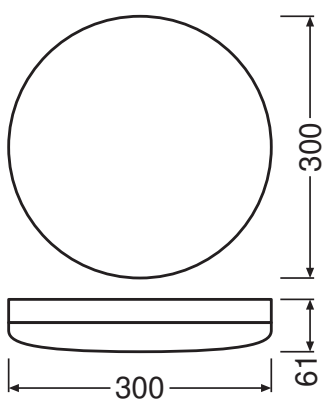

SF Compact 300 24W IK10 IP65

Materials & Colors

Product color	White
Housing color	White
Body material	Polycarbonate (PC)
Cover material	Polycarbonate (PC)
Light emitting surface material	Polycarbonate (PC)
Glow Wire Test according to IEC 60695-2-12	850 °C
Mercury content	0.0 mg

### Application & Mounting

Ambient temperature range	-20...+50 °C
Type of connection	Screwless terminal, 3-Pole
Type of protection	IP65
Protection class IK (shock resistance)	IK10
Dimmable	No
Mounting type	Surface
Mounting location	Ceiling / Wall
Application environment	Indoor
LED module replaceable	Not replaceable
With light source	Yes

### Lifespan

Lifespan L70/B50 at 25 °C	50000 h <sup>1)</sup>
Lifespan L80/B10 at 25 °C	30000 h <sup>1)</sup>
Lifespan L90/B10 at 25 °C	15000 h
Number of switching cycles	100000

<sup>1)</sup> t[h]: L70 / B50 @ 25 °C (Ta), t[h]: L80 / B10 @ 25 °C (Ta), t[h]: L90 / B10 @ 25 °C (Ta)







### Control gear







Output current	280 mA
----------------	--------



### Certificates & Standards

Standards	CE / CB / ENEC / TÜV SÜD / EAC
Luminaire with limited surface temperature, "D sign"	Yes
Ball shot safe	No

### DOWNLOAD DATA

Documents and certificates		Document name
	User Instruction	SURFACE COMPACT IK10
	Addon Technical Information	LS Insert SF Compact IK10
	On-Pack-Info	Legal Insert Surface
	Declarations of conformity	SURFACE COMPACT IK10
	Declarations of conformity	EC declaration of surface compact IK10 LEDV
	Declarations Of Conformity UKCA	SF Compact 300 IK10 IP65
	Certificates	CE Certificate Sruface Compact RD300 24W

Photometric and lighting design files		Document name
	IES file (IES)	SF Compact RD300 24W 4000K IP65 IK10 WT
	LDT file (Eulumdat)	SF Compact RD300 24W 4000K IP65 IK10 WT
	ULD file (DIALux)	SURFACECOMPACTIK1024W4000KIP65WT
	ROLF file (RELUX)	SF COMPACT 300 24W-4000K
	UGR file (UGR table)	4058075062221 SF Compact RD300 24W 4000K IP65 IK10 WT
	LDC typ cone	4058075062221 SF Compact RD300 24W 4000K IP65 IK10 WT
	LDC typ polar	4058075062221 SF Compact RD300 24W 4000K IP65 IK10 WT

CAD/BIM files		Document name
	BIM_Revit_3D	SURFACE-COMPACT IK10
	CAD_STEP_3D	SF Compact IK10

Tender texts		Document name
	Tender documents	SURFACE COMPACT IK10 24 W 4000 K IP65 WT-EN

LOGISTICAL DATA

Product code	Packaging unit (Pieces/Unit)	Dimensions (length x width x height)	Gross weight	Volume
4058075062221	Folding box 1	61 mm x 304 mm x 304 mm	1060.00 g	5.64 dm <sup>3</sup>
4058075062238	Shipping box 8	555 mm x 320 mm x 325 mm	9430.00 g	57.72 dm <sup>3</sup>

The mentioned product code describes the smallest quantity unit which can be ordered. One shipping unit can contain one or more single products. When placing an order, for the quantity please enter single or multiples of a shipping unit.

ADDITIONAL CATALOG INFORMATION

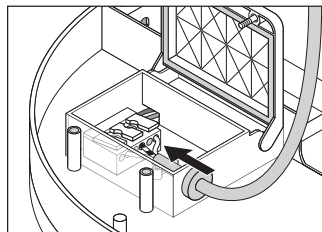
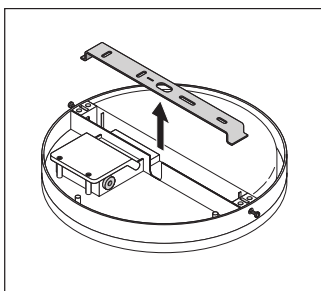

References / Links

– For Guarantee see [www.ledvance.com/guarantee](http://www.ledvance.com/guarantee)

DISCLAIMER

Subject to change without notice. Errors and omission excepted. Always make sure to use the most recent release.